

Death Star Module 1b - (c) Martin Hunt 2016

Folding time, approx. 20-30 mins

Start with a square, colour side down

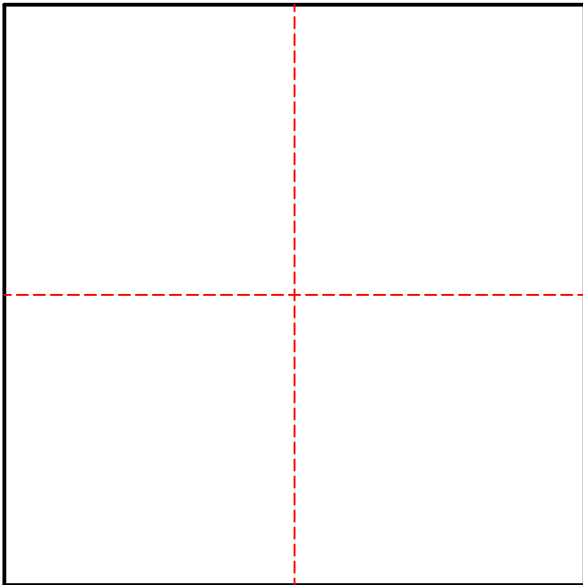

1. Fold in half horizontally and vertically

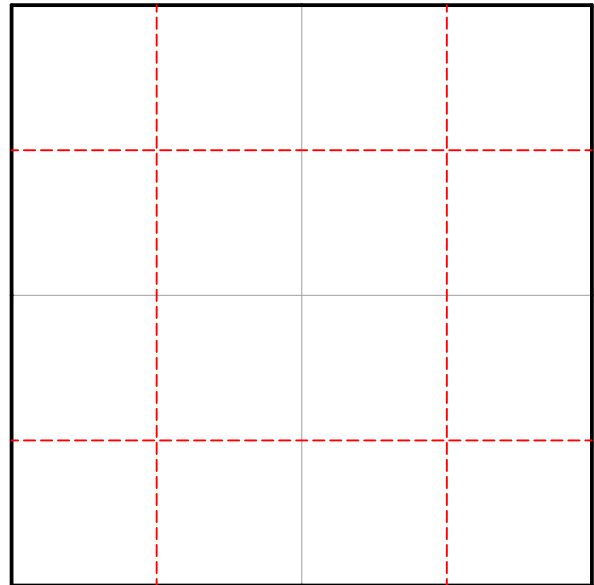

2. Fold all four edges to the centre line and unfold

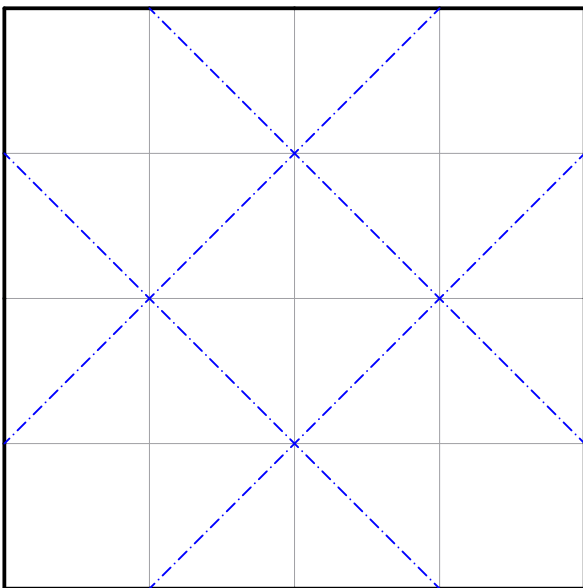

3. Mountain fold the marked diagonal creases

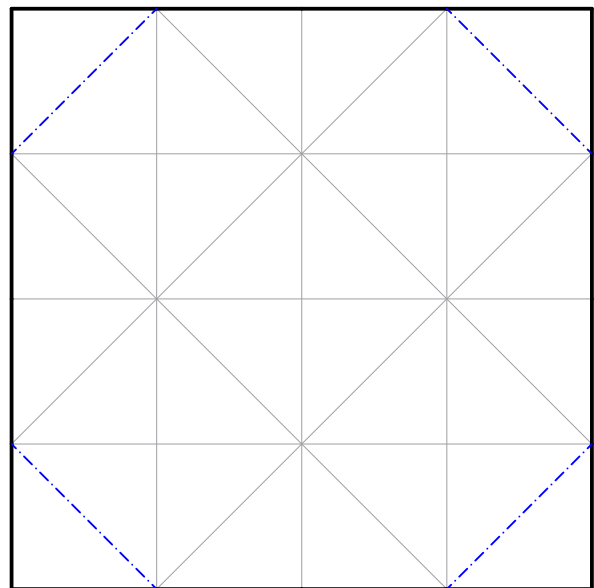

4. Mountain fold the corners using the marked diagonal creases

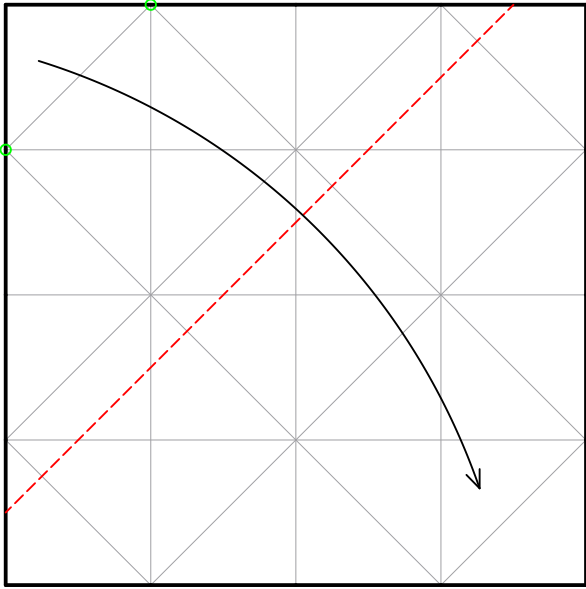

5. Fold the top left corner to the crease made in the previous step ensuring that the marked intersections line with the long diagonal creases from step 3

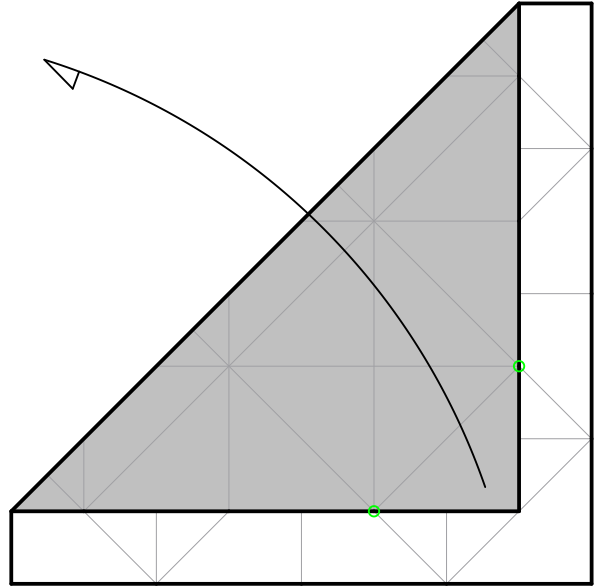

6. Like so. Unfold to the previous step

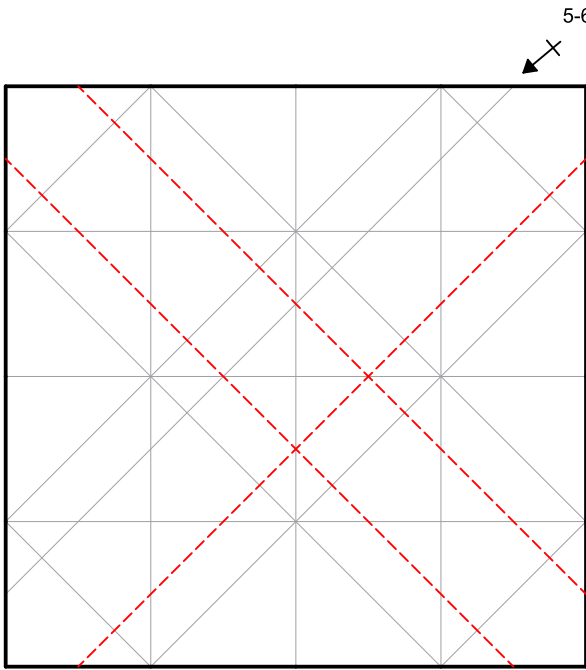

7. Repeat steps 5 and 6 on the three remaining corners

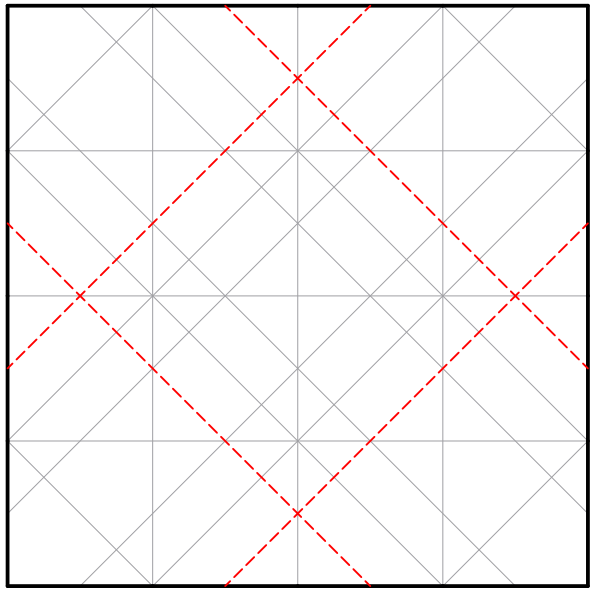

8. Fold the marked diagonal creases in the same way

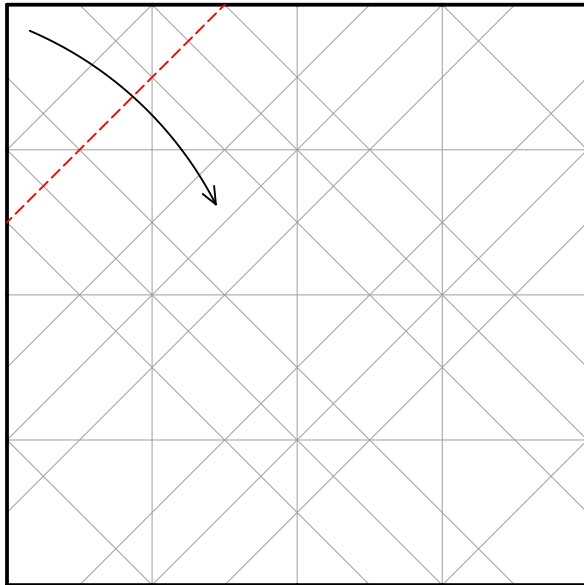

9. Fold the top left corner where the creases from the previous step intersect the edges

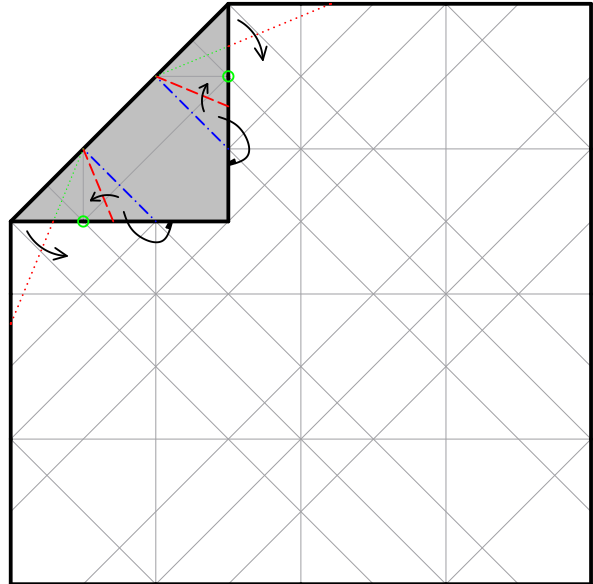

10. Swivel the edges of the flap underneath to create the angle bisectors shown. The mountains fold lie along existing creases. Only crease the top flap firmly

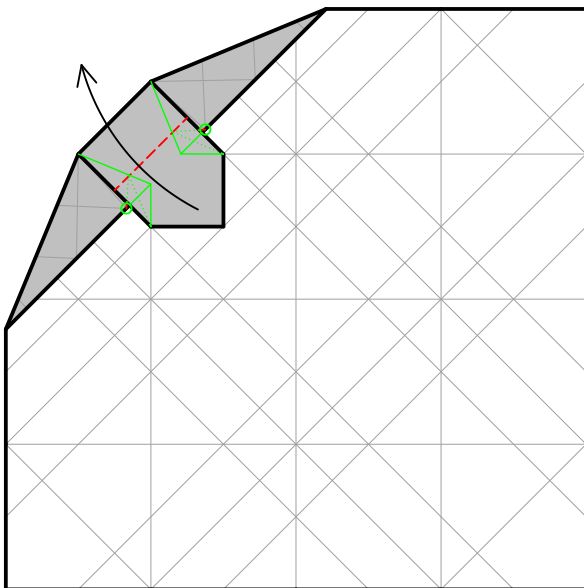

11. Like so. Fold the tip of the flap out along the existing crease, forming the rabbit ears shown

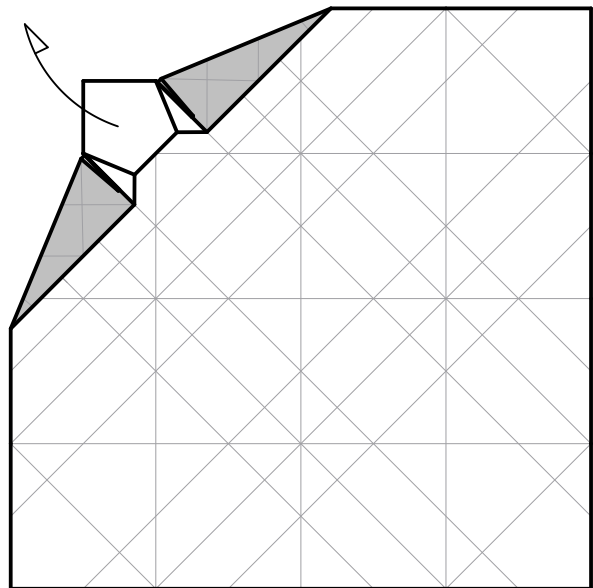

12. Like so. Unfold back to step 9

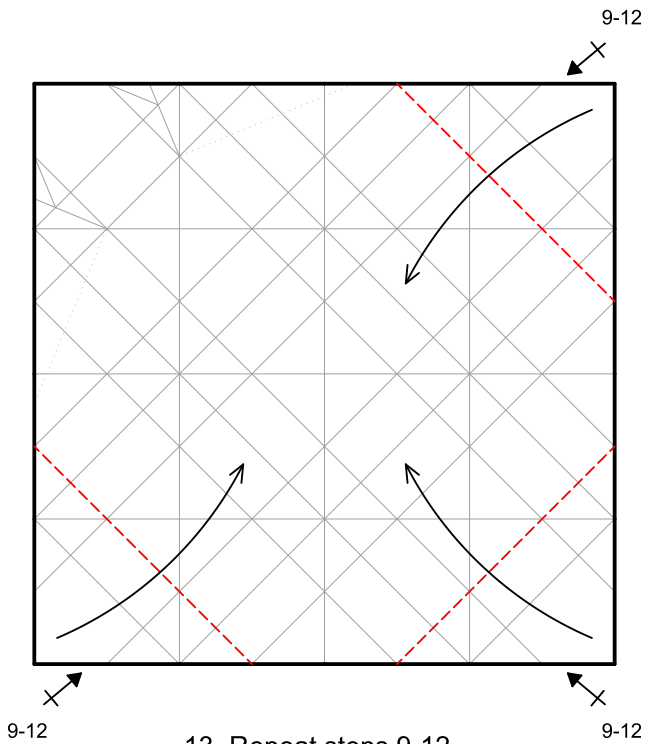

9-12 13. Repeat steps 9-12 on the three remaining corners

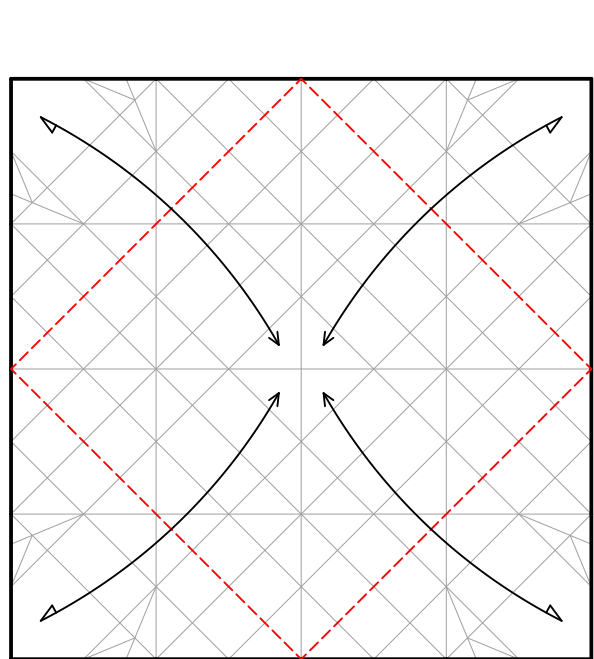

9-12 14. Fold the corners to the centre, and unfold

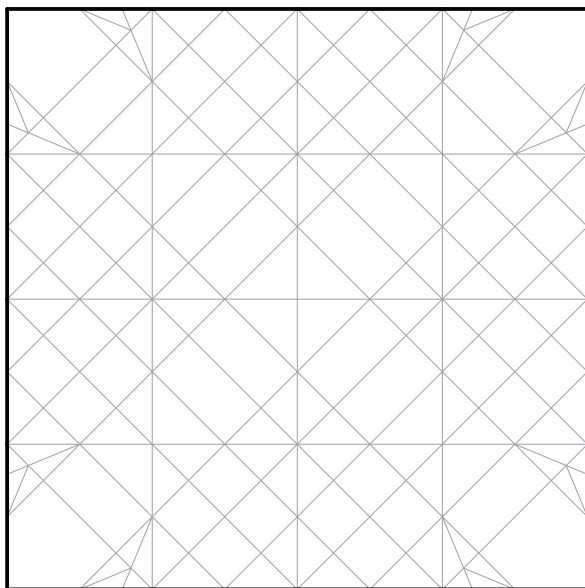

15. The precreasing is complete. Turn over.

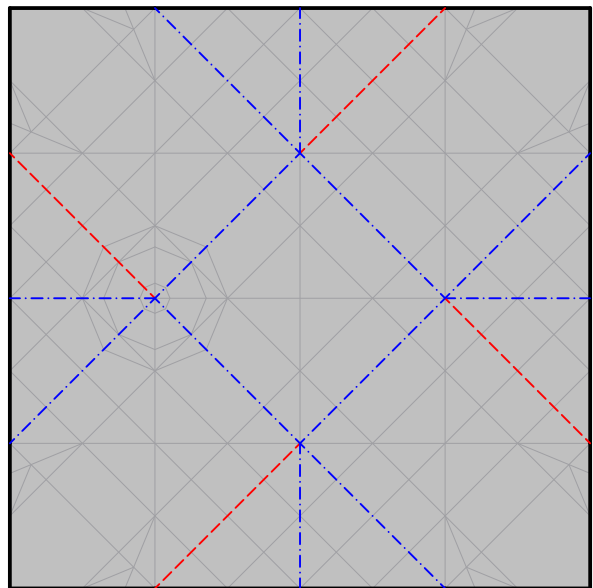

16. Form a box using the marked creases



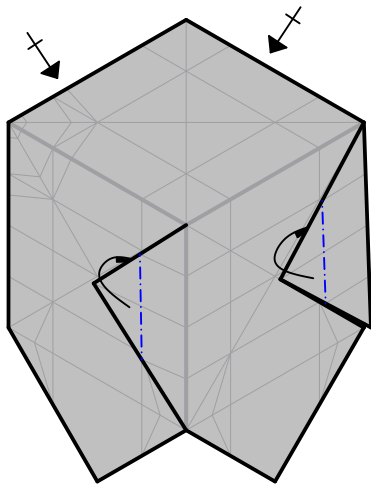

17. Mountain fold half of each triangular flap underneath

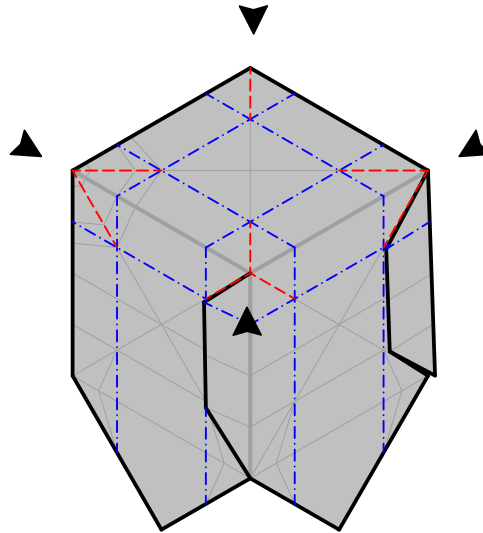

18. Sink all four corners to create inverted pyramids. The box will now be octagonal in shape

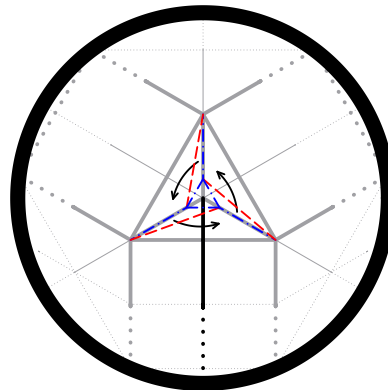
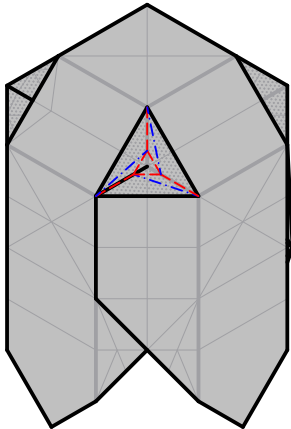

19. Gently squash the pyramid from the inside by twisting it, easing it flat from the corners. A small pyramid should remain at the very centre. Both exterior and interior views are shown

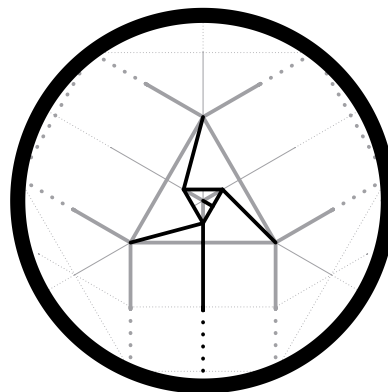
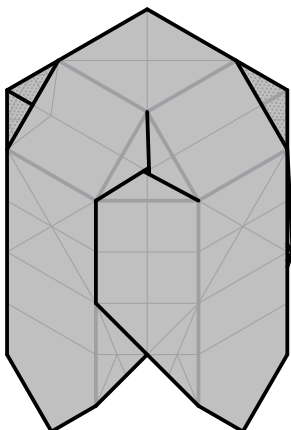

20. Like so. The triangular face is now flush with all three adjacent edges. Rotate the model 90 degrees clockwise

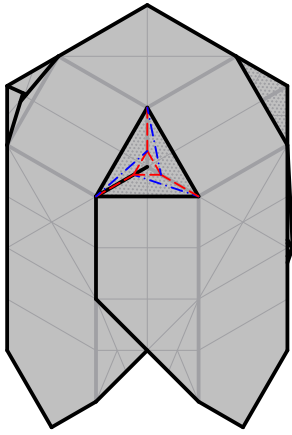

21. Repeat steps 19 and 20 on the three remaining corners

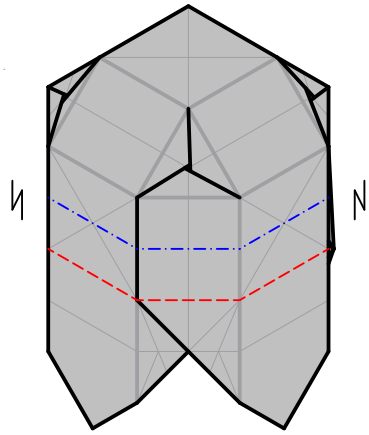

22. Pleat the lower half of the model inside along existing creases

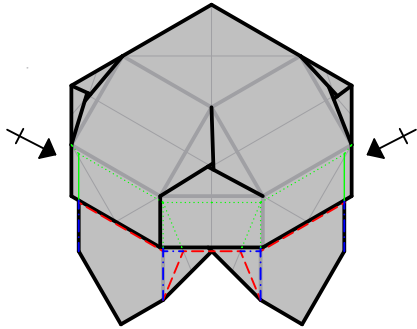

23. Refold the tabs made in steps 9-13

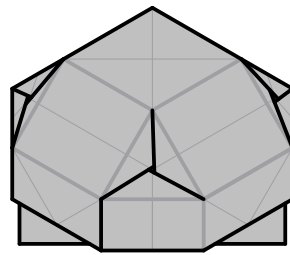

24. Like so.
The unit is now complete

x1