

Naboo Starfighter - (c) Martin Hunt 2012

Folding time, approx. 15-20 mins

Start with a square, colour side down

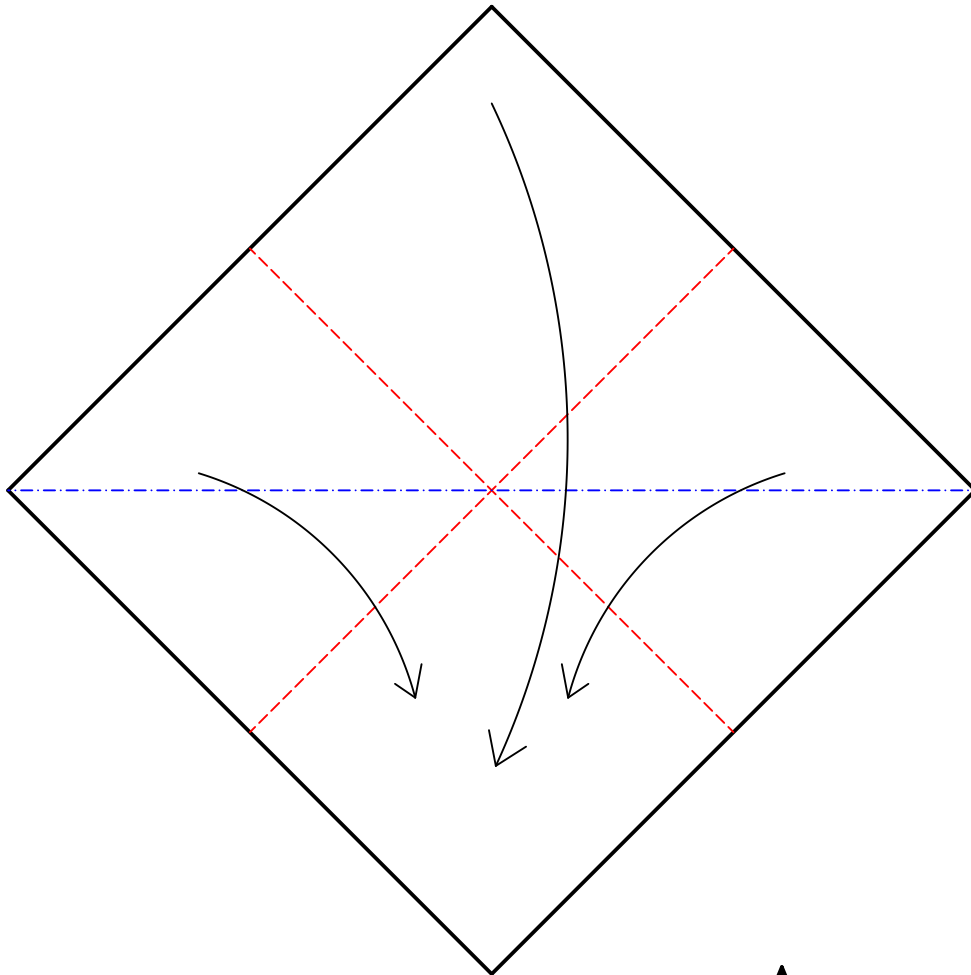

1. Make a preliminary fold

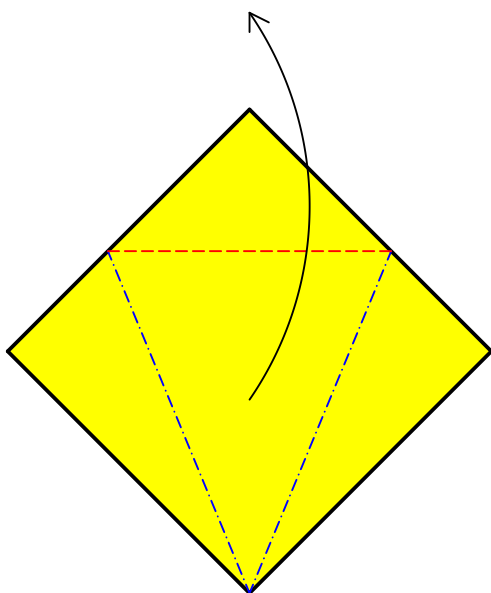

2. Petal fold the top flap

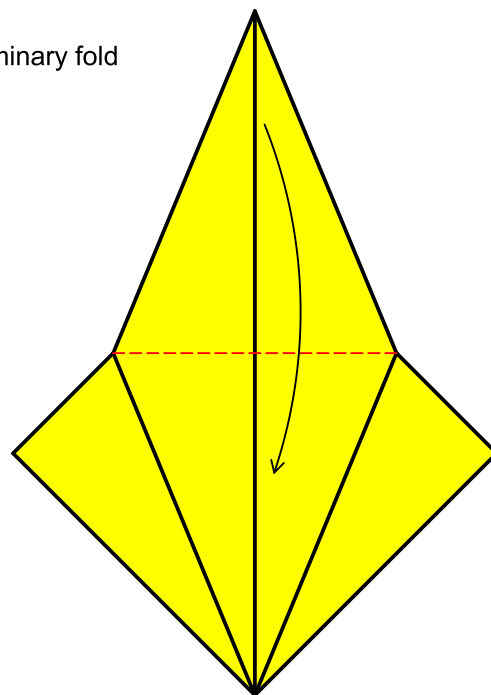

3. Valley fold back down

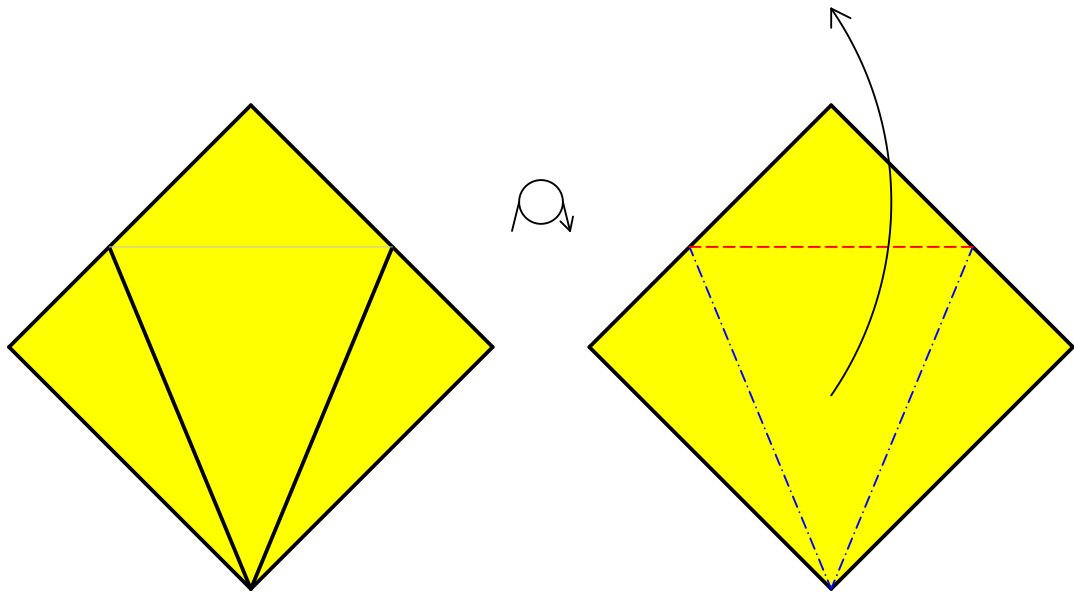

4. Turn over

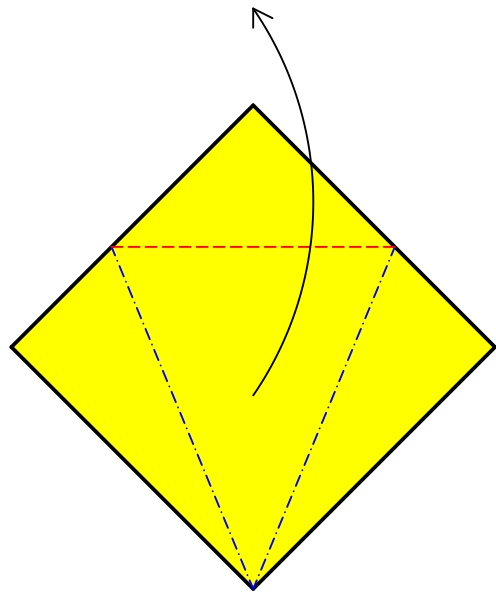

5. Petal fold, as in step 2

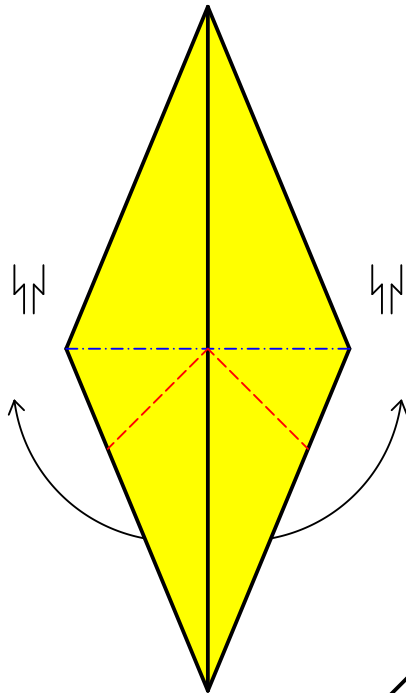

6. Crimp the flaps upwards

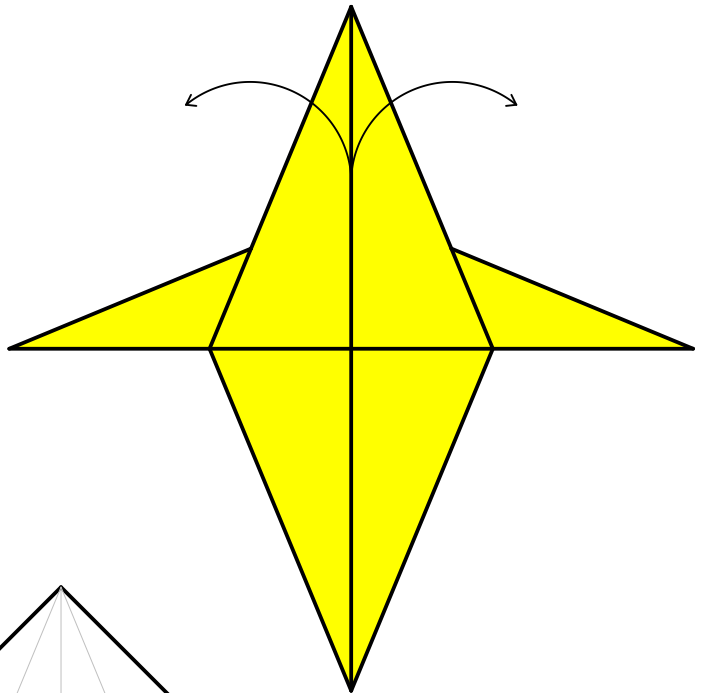

7. Like so.
Unwrap the trapped layers

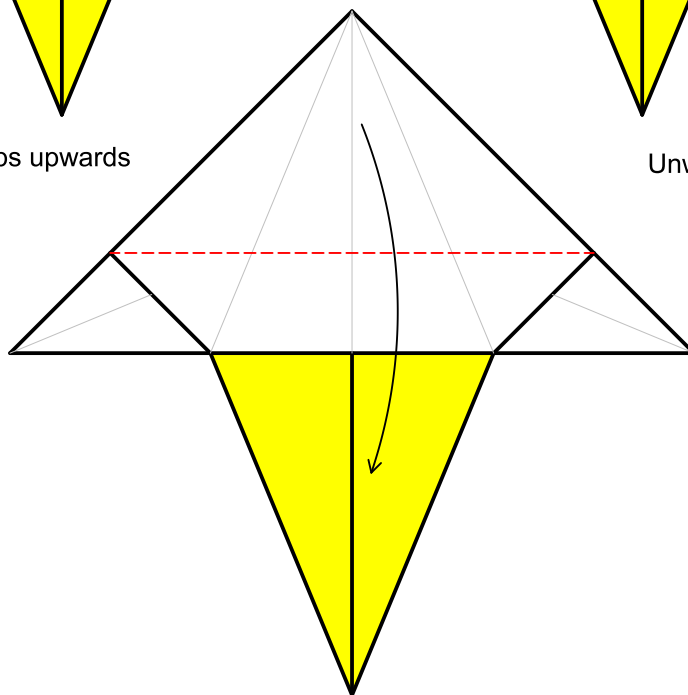

8. Like so. Valley fold the large flap down

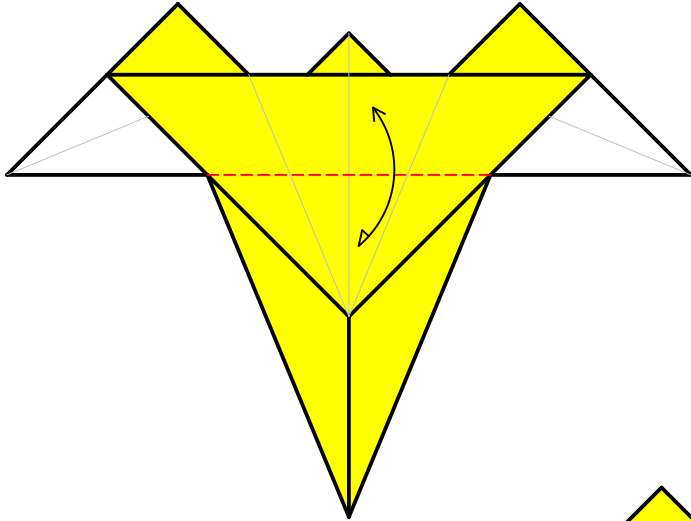

9. Fold and unfold

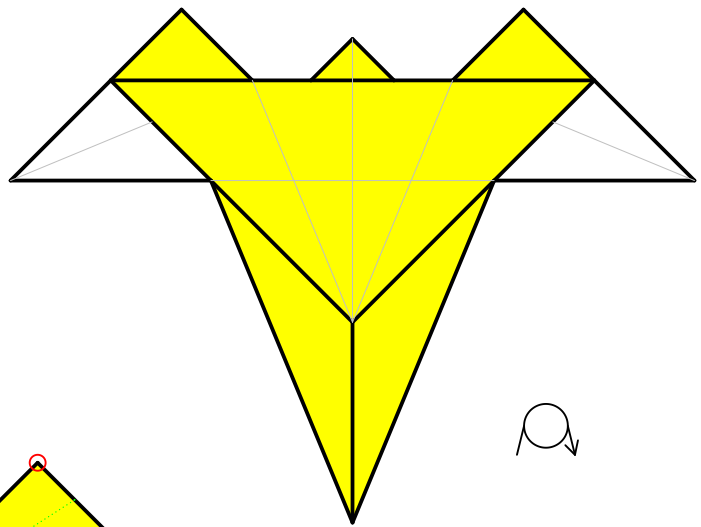

10. Turn over

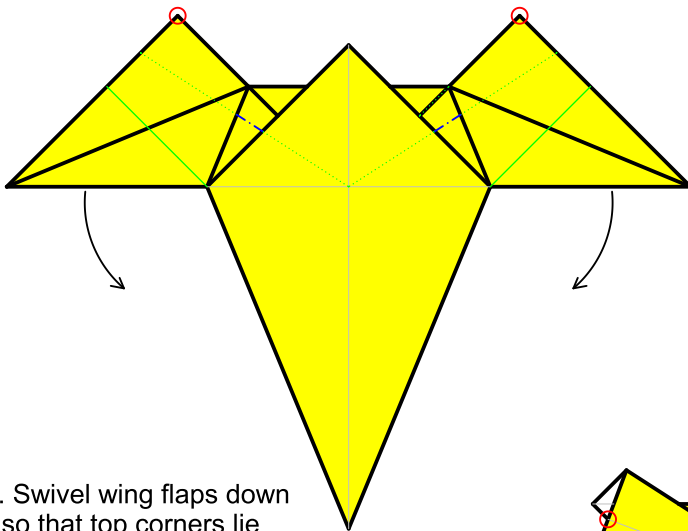

11. Swivel wing flaps down so that top corners lie on the hidden edges below

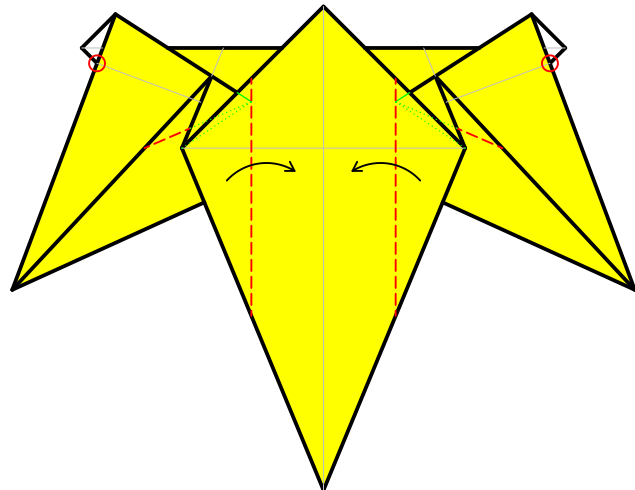

12. Like so. Fold edges to the centre line, squashing the layers below

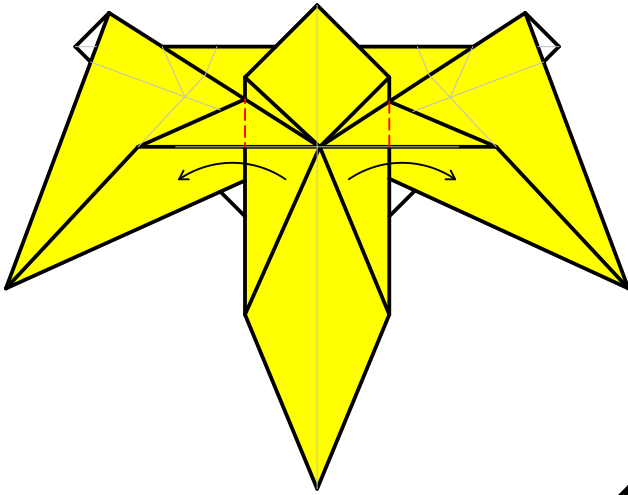

13. Valley fold back out

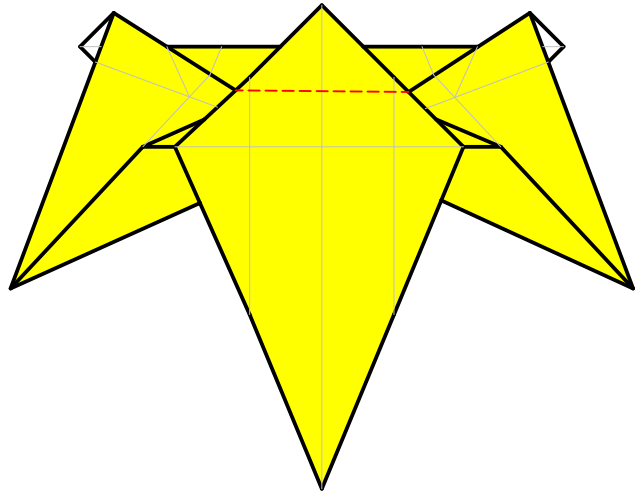

14. Fold flap down as far as possible

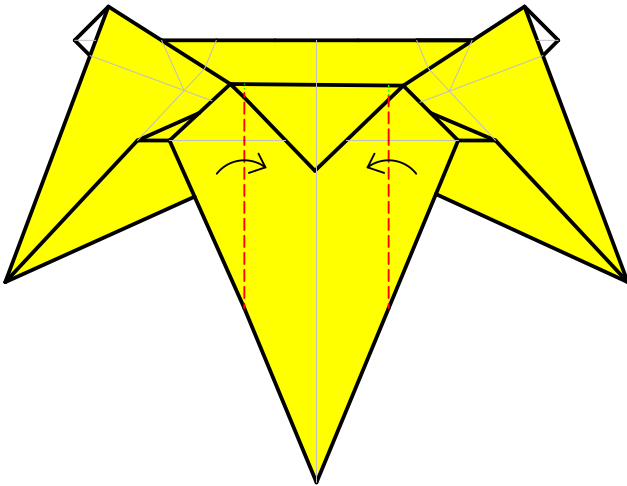

15. Tuck side flaps into the pockets just created

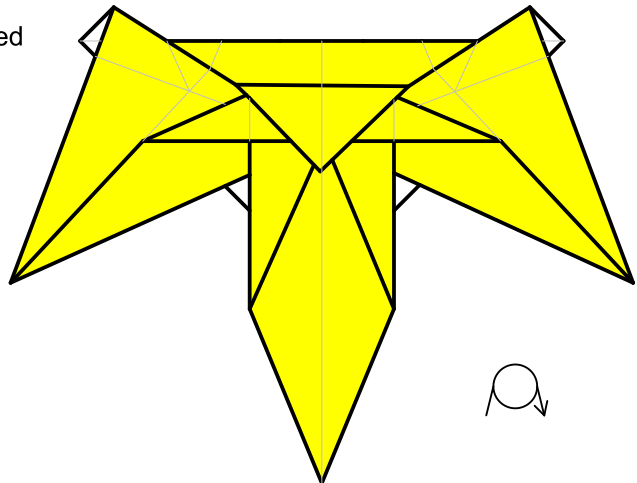

16. Turn over

17. Fold and unfold the angle bisectors

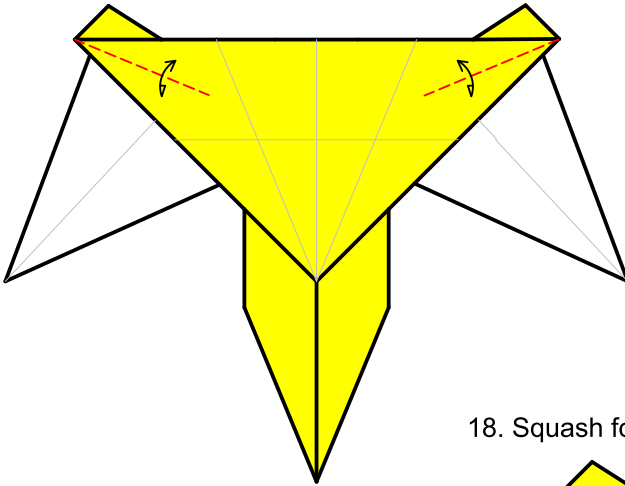

18. Squash fold to bring the outer edges to lie vertically

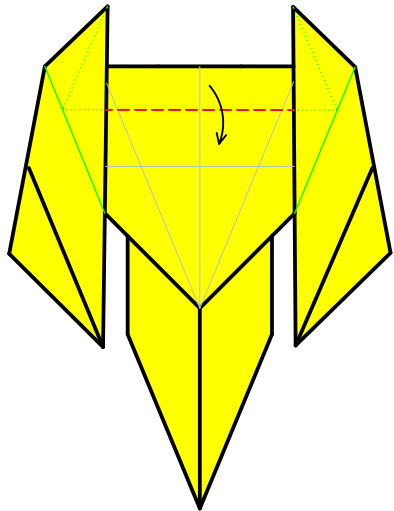
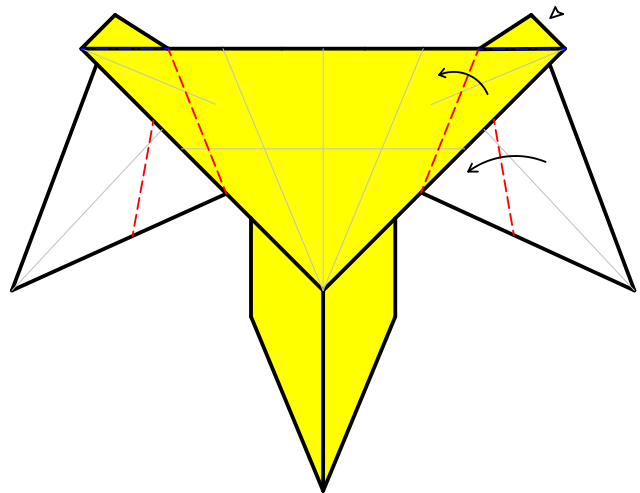

19. Fold down in line with the edge below.
Reverse folds should form on the creases made in step 17

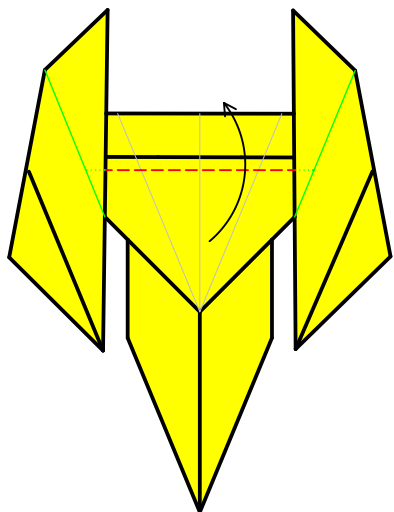

20. Fold the flap up on an existing crease

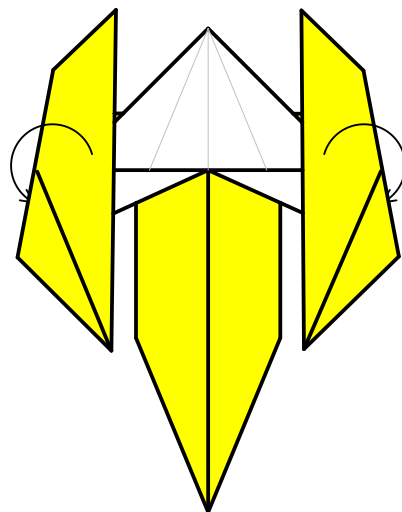

21. Wrap one layer round on each side

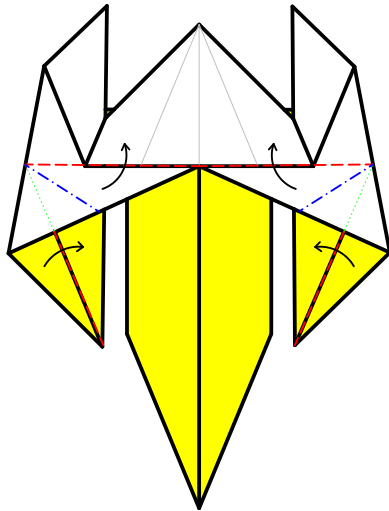

22. Swivel folds

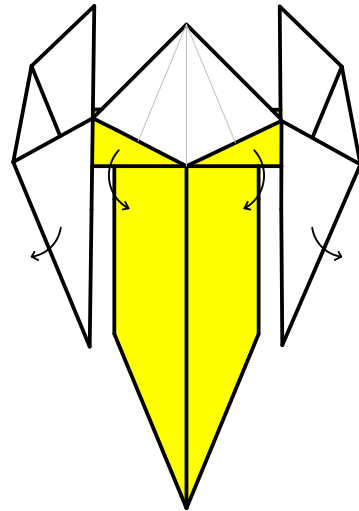

23. Unfold to step 22

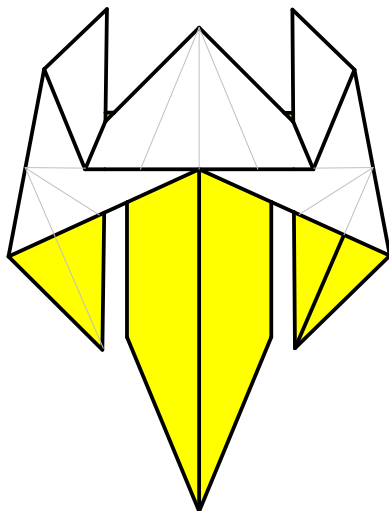

24. Turn over

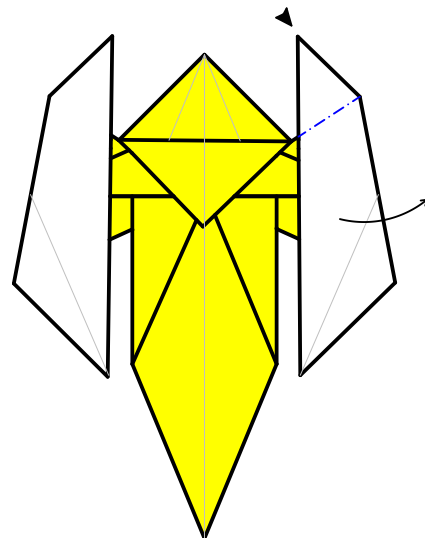

25. Open up the flap, squashing the tip.
Do not crease firmly

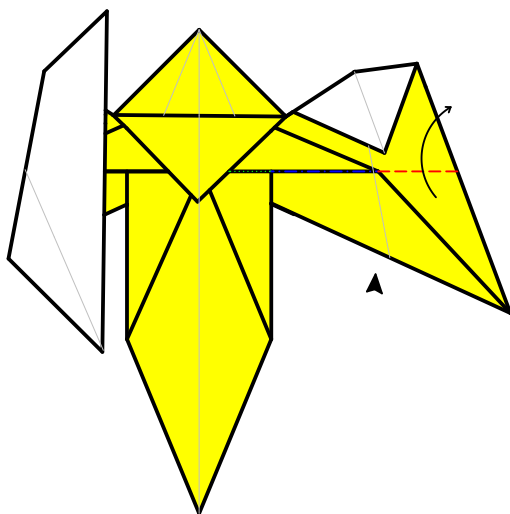

26. Reverse fold

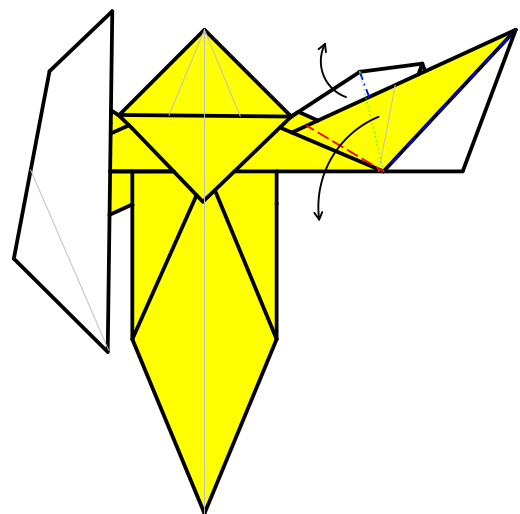

27. Valley fold, closing the flap and releasing the tip

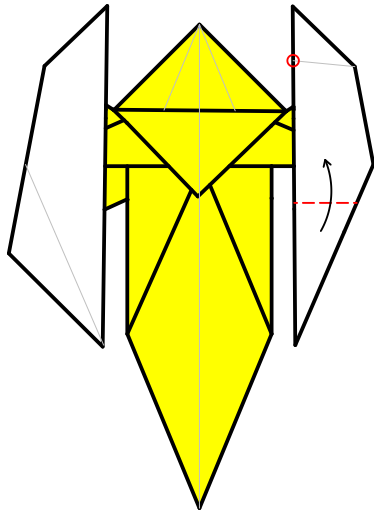

28. Valley fold. The end of the flap should touch an existing crease

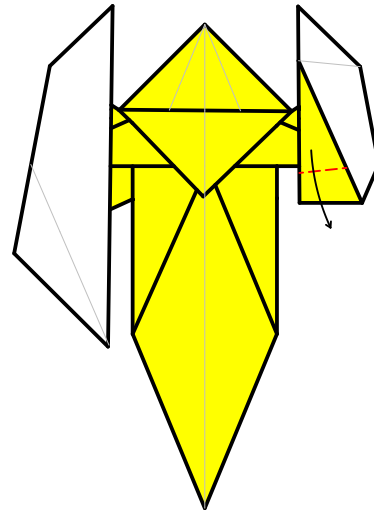

29. Fold down at a slight angle

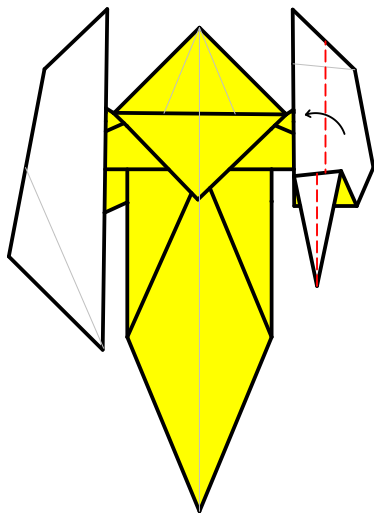

30. Fold in half through all layers

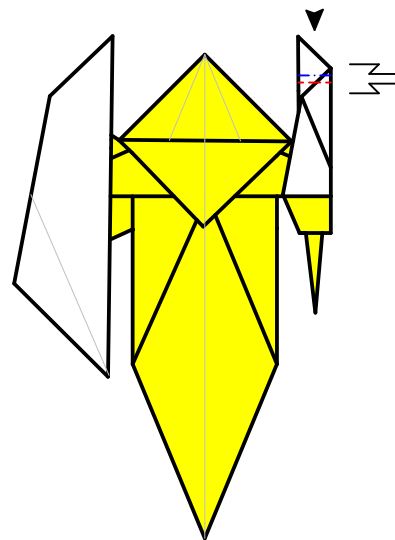

31. Sink the tip in and out

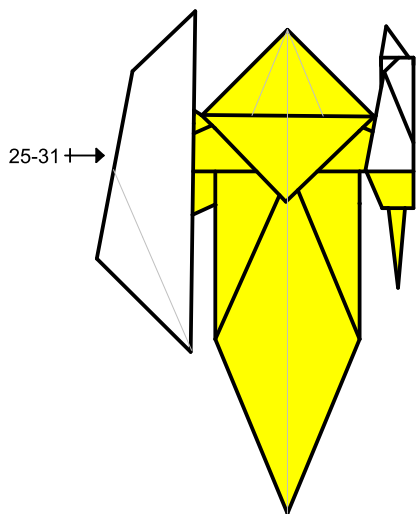

32. Repeat steps 25-31 on the left

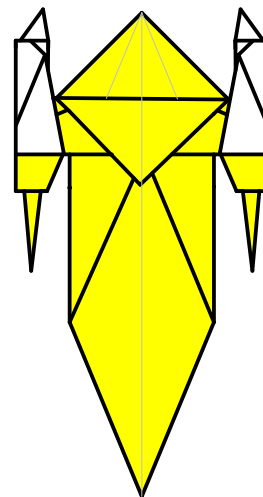

33. Turn over

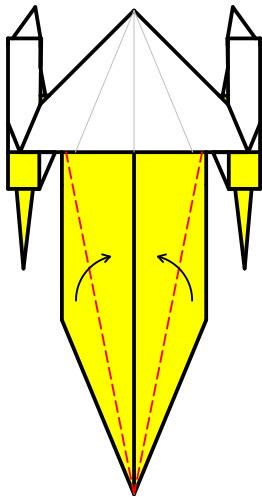

34. Valley fold to the centre

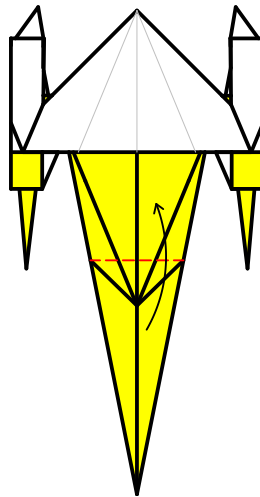

35. Valley fold where the edges intersect

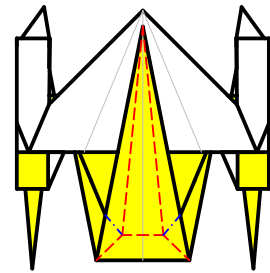

36. Double rabbit ear

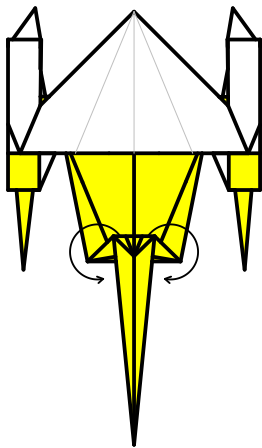

37. Bring the trapped layers to the top

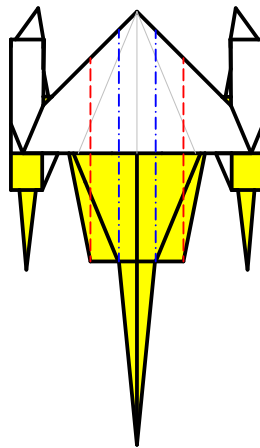

37. Pleat through all layers to make the model 3 dimensional

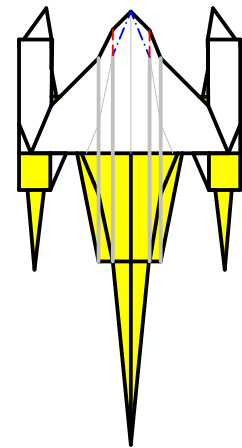

38. Narrow the tip using existing creases

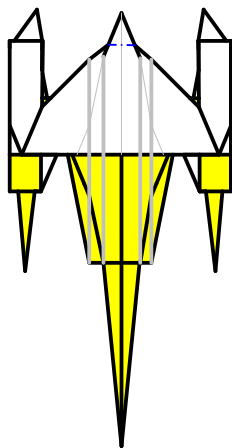

39. Tuck the flap under to lock in place

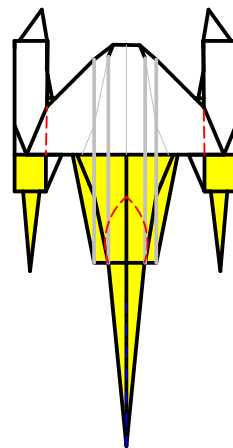

40. Fold up and round out the engines.
Pinch the tail.
Open the cockpit.